

SOFTWARE REQUIREMENTS	
Fronius Datamanager 2.0	≥ 3.16.1 version
Fronius Symo Hybrid	≥ 1.16.1 version
MEASURING INPUT	
Three-phase nominal voltage range	400 - 480 V (-20 % to +15 %)
Operating voltage range	173 - 400 VLL ± (2 % RDG/accuracy)
Single-phase nominal voltage range	230 - 277 V (-20 % to +15 %)
Operating voltage range	100 - 230 VLN ± (1 % RDG/accuracy)
Voltage transformer ratio (kVT)	1 - 1000 / e. g. VT 20000/400V kVT = 50 / for direct connection: kVT = 1
Protection level 8/20 μs (U _p) (star mounting)	4 kV
Current withstand short circuit PV (I _{scpv})	15000 A
Self-consumption - voltage path (max. voltage)	10 VA
Nominal frequency	50 - 60 Hz
Tolerance	45 - 65 Hz
Nominal current, I _b	1 A + 5 A
Maximum current, I _{max}	6 A
Starting current	10 mA
Current transformer ratio (kCT)	1 - 1000 e. g. TC 800/5A kCT = 160 for direct connection: kCT = 1
Short-time overload (EN IEC 62053-21, EN IEC 62053-23)	5 I _{max} / 0.5 s
Self-consumption - current path (max. current)	0.3 W per phase
Maximum value kVT x kCT	1000 (CT/5A)
Current distortion factor	in acc. with EN IEC 62053-21
Power factor Operating range (EN IEC 62053-21, EN IEC 62053-23)	active cosφ 0.5 ind - 0.8 cap, reactive sinφ 0.5 ind - 0.5 cap
ENERGY	
LED indicator	1 pulse / 0.1 Wh
Active energy accuracy (EN IEC 62053-21)	Class 1 Class 2: 100 - 230 VLN (173 - 400 VLL)
Reactive energy accuracy (EN IEC 62053-23)	Class 2
Response time after switch-on (EN IEC 62053-21, EN IEC 62053-23)	< 5 s
OUTPUT	
RS485 communication (Electrically isolated from input and auxiliary voltage)	
Standard	RS485 - 3 conductors
Protocol	Modbus RTU
Addresses	1 - 255
Baud rate	9600, 19200, 38400 bit/s
Response time	≤ 200 ms
INSULATION (EN IEC 62052-11, EN IEC 62053-21)	
Installation category	III
Degree of pollution	2
Insulation voltage	4 kV RMS
Impulse withstand voltage	4 kV 1.2/60 μs
Test circuit	Voltage input, current input, pulse output, communication
Test voltage	2.75 kV RMS, 50 Hz/1 min
Test circuit	Voltage input, current input, pulse output, communication
Test voltage	4 kV RMS, 50 Hz/1 min
Test circuit	All circuits and earth
ELECTROMAGNETIC COMPATIBILITY	
Test in acc. with EN IEC 62052-11	
OPERATING CONDITIONS	
Reference temperature	25 °C (± 5 °C)
Operating range	-25 to +65 °C
Temperature limit for storage and transport	-30 to +80 °C
Max. power loss (for thermal dimensioning of the switch cabinet)	≤ 2.8 W
HOUSING	
Housing	3 modules according to DIN 43880
Sealable housing/terminal cover	
Connection	Screw connection
Mounting	Can be snapped onto 35 mm DIN rail
Housing material	Noryl, self-extinguishing
Degree of protection (EN 60529)	IP54 housing, IP20 connections
Weight	240 grams
TERMINALS - MEASURING INPUT	
Wire	min. 1 mm ² / max. 4 mm ²
Recommended torque	max. 0,6 Nm
TERMINALS - DATA OUTPUT	
Wire	min 0.05 mm ²
Recommended torque	max. 0.4 Nm

Detailed, country-specific warranty terms are available on: www.fronius.com/solar/warranty

/ Perfect Welding / Solar Energy / Perfect Charging



FIND MORE INFORMATION

manuals.fronius.com/html/4204260348

QUICK START GUIDE

Fronius Smart Meter TS 5kA-3



DE: WARNUNG! Fehlbedienung und fehlerhaft durchgeführte Arbeiten können schwerwiegende Personen- oder Sachschäden verursachen. Die Installation und Inbetriebnahme des Smart Meters darf nur durch geschultes Personal und nur im Rahmen der technischen Bestimmungen erfolgen. Vor Arbeiten mit dem Gerät, alle beiliegenden, aufgedruckten und online zur Verfügung gestellten Dokumente lesen und verstehen! Dieses Dokument beschreibt nicht alle möglichen Systemkonfigurationen.

EN: WARNING! Incorrect operation and incorrectly performed work can cause serious personal injury or material damage. The Fronius Smart Meter may only be installed and commissioned by trained personnel and only within the scope of the technical regulations. Before working with the device, read and understand all enclosed, printed and online documents! This document does not describe all of the possible system configurations.

FR: AVERTISSEMENT ! Une mauvaise utilisation et un travail mal effectué peuvent causer des blessures graves ou des dommages matériels. Le Fronius Smart Meter ne peut être installé et mis en service que par du personnel formé et uniquement dans le cadre des réglementations techniques. Avant de travailler avec l'appareil, lisez et comprenez tous les documents ci-joints, imprimés et en ligne ! Ce document ne décrit pas toutes les configurations possibles du système.

IT: ATTENZIONE! Un funzionamento non corretto e un lavoro eseguito in modo non corretto possono causare gravi lesioni personali o danni materiali. Lo Fronius Smart Meter può essere installato e messo in funzione solo da personale addestrato e solo nell'ambito delle norme tecniche. Prima di lavorare con l'apparecchio, leggere e comprendere tutti i documenti allegati, stampati e online! Questo documento non descrive tutte le possibili configurazioni di sistema.

ES: ¡ADVERTENCIA! El funcionamiento incorrecto y el trabajo realizado de forma incorrecta pueden causar graves lesiones personales o daños materiales. El Fronius Smart Meter sólo puede ser instalado y puesto en marcha por personal capacitado y sólo dentro del ámbito de los reglamentos técnicos. Antes de trabajar con el dispositivo, lea y entienda todos los documentos adjuntos, impresos y en línea! Este documento no describe todas las configuraciones posibles del sistema.

DA: ADVARSEL! Forkert betjening og forkert udført arbejde kan forårsage alvorlig personskade eller materielle skader. Fronius Smart Meter må kun installeres og idriftsættes af uddannet personale og kun inden for rammerne af de tekniske forskrifter. Læs og forstå alle vedlagte, trykte og online dokumenter, før du arbejder med enheden! Dette dokument beskriver ikke alle mulige systemkonfigurationer.



42,0410,2495

004-13102020

FRONIUS INTERNATIONAL GMBH

www.fronius.com

1 SWITCH OFF THE CIRCUIT BREAKER (Step: 1)

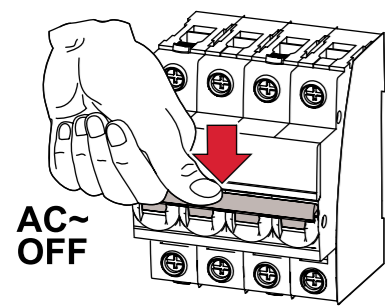

2 MOUNT THE SMART METER (Step: 2)

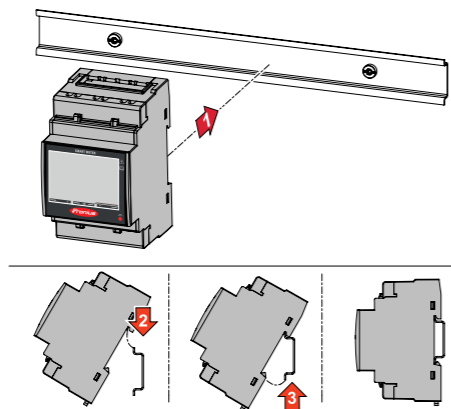

3 CONNECT THE AUXILIARY POWER SUPPLY (Step: 3)

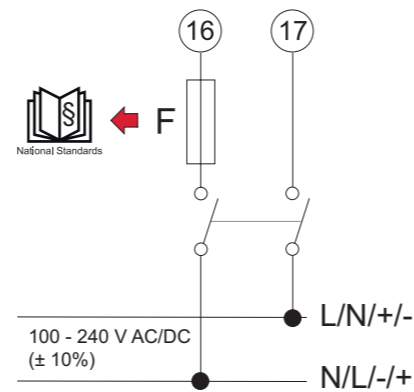

4a 1 PHASE, 2 WIRES - CT (Step: 4a)

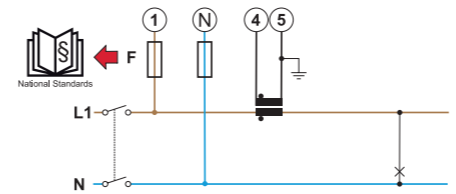

4b 1 PHASE, 2 WIRES - VT/CT (Step: 4b)

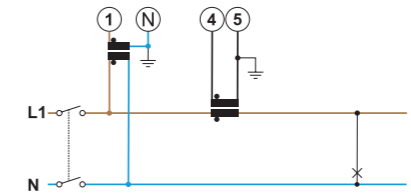

4c 2 PHASES, 3 WIRES - CT (Step: 4c)

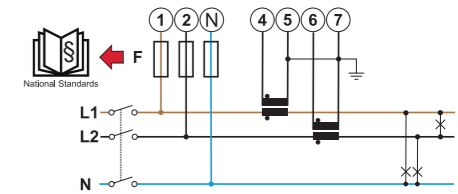

4d 2 PHASES, 3 WIRES - VT/CT (Step: 4d)

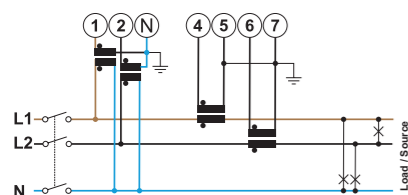

4e 3 PHASES, 3 WIRES - CT (Step: 4e)

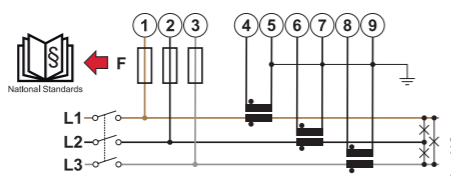

4f 3 PHASES, 3 WIRES - VT/CT (Step: 4f)

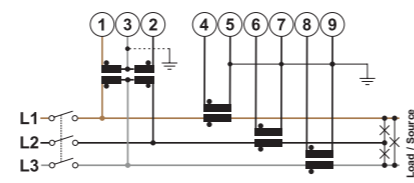

4g 3 PHASES, 4 WIRES - ARON CT (Step: 4g)

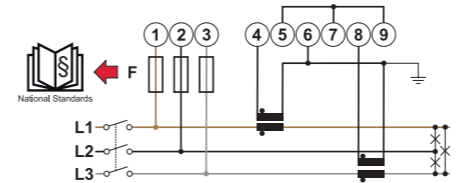

4h 3 PHASES, 4 WIRES - CT (Step: 4h)

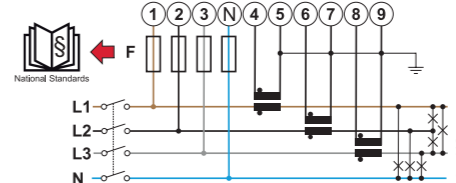

4i 3 PHASES, 4 WIRES - VT/CT (Step: 4i)

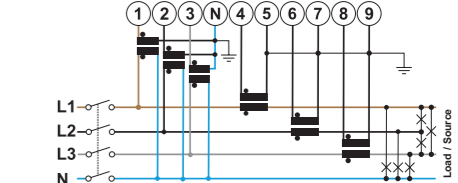

5 CONNECT THE DATA CABLES (Step: 5)

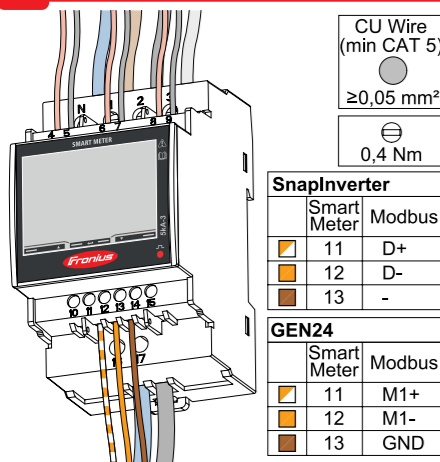

6 SET UP THE TERMINATING RESISTOR (Steps: 6-7)

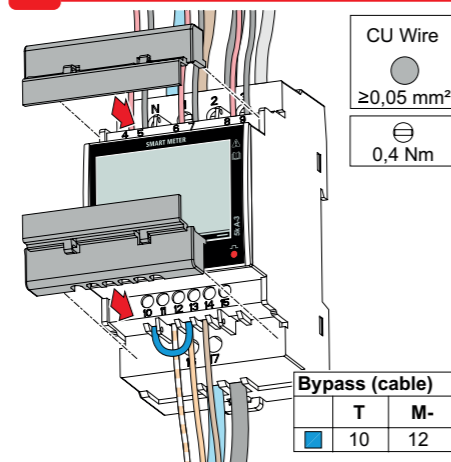

7

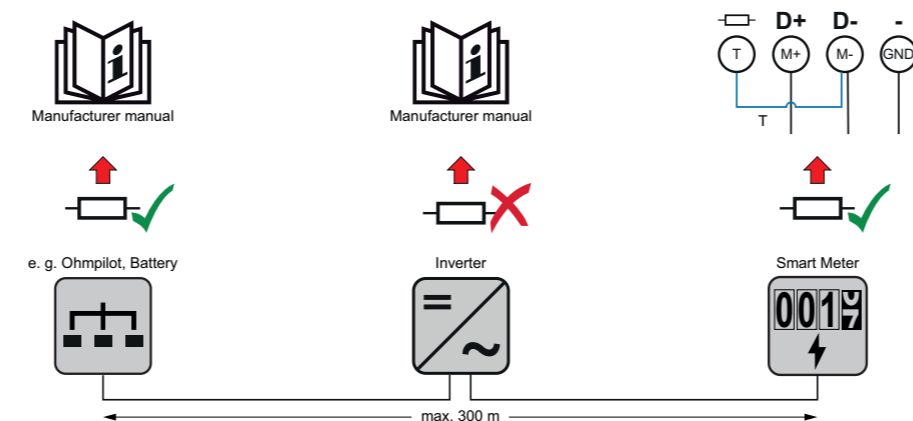

8 SWITCH ON THE CIRCUIT BREAKER (Step: 8)

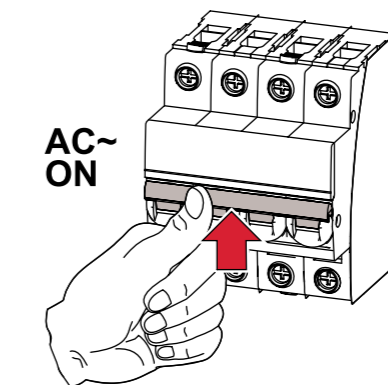

9 NAVIGATE IN THE SETTINGS (Step: 9)

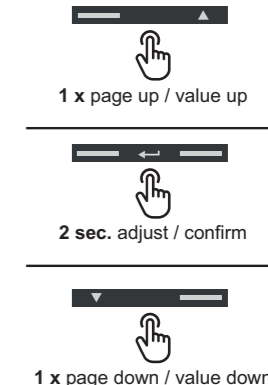

10 ENTER THE SETTINGS (Step: 10)

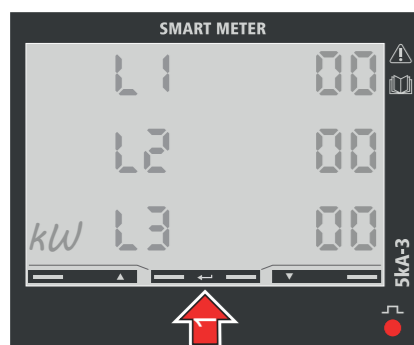

11 SETUP THE PASSWORD (Step: 11)

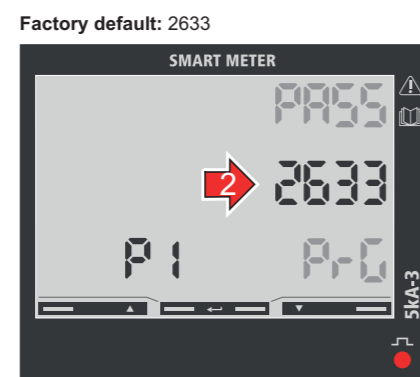

12 SETUP THE TRANSFORMATION RATIO (Step: 12)

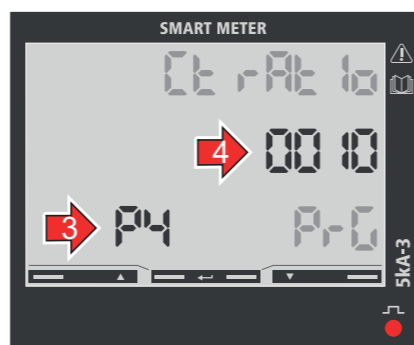

13 SETUP THE ADDRESS (Step: 13)

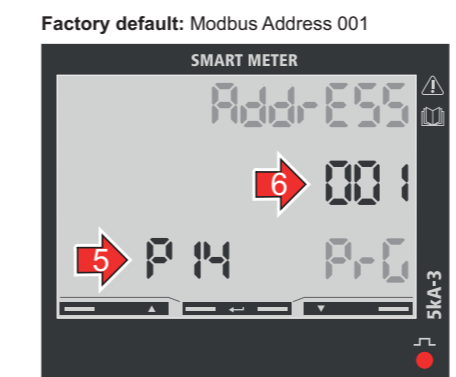

14 EXIT THE SETTINGS (Step: 14)

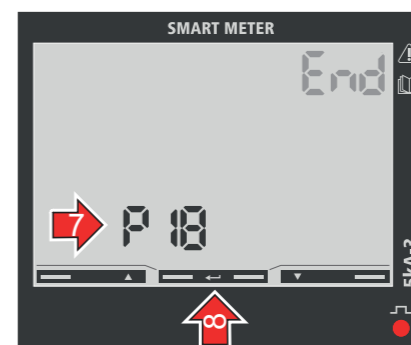

15 START UP THE SMART METER (Step: 15)

